

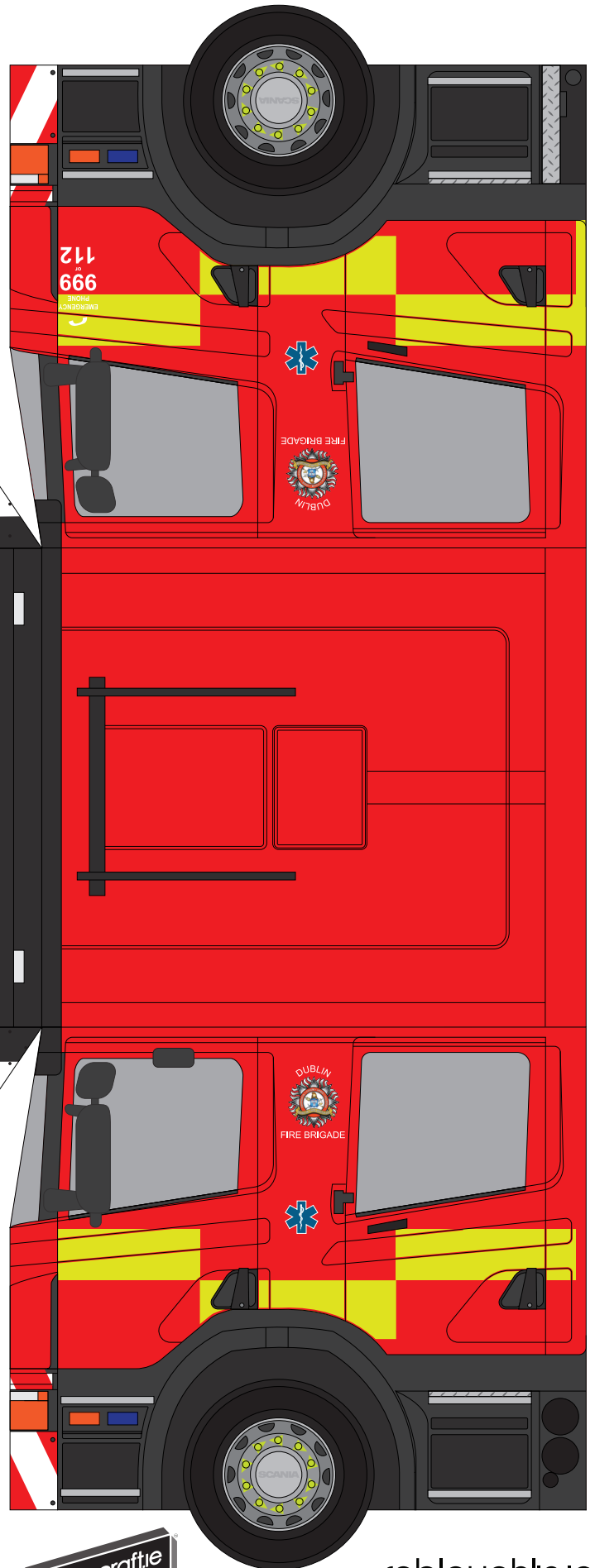

© Copyright robbloughlin.ie 2024. Not to be reproduced without permission.

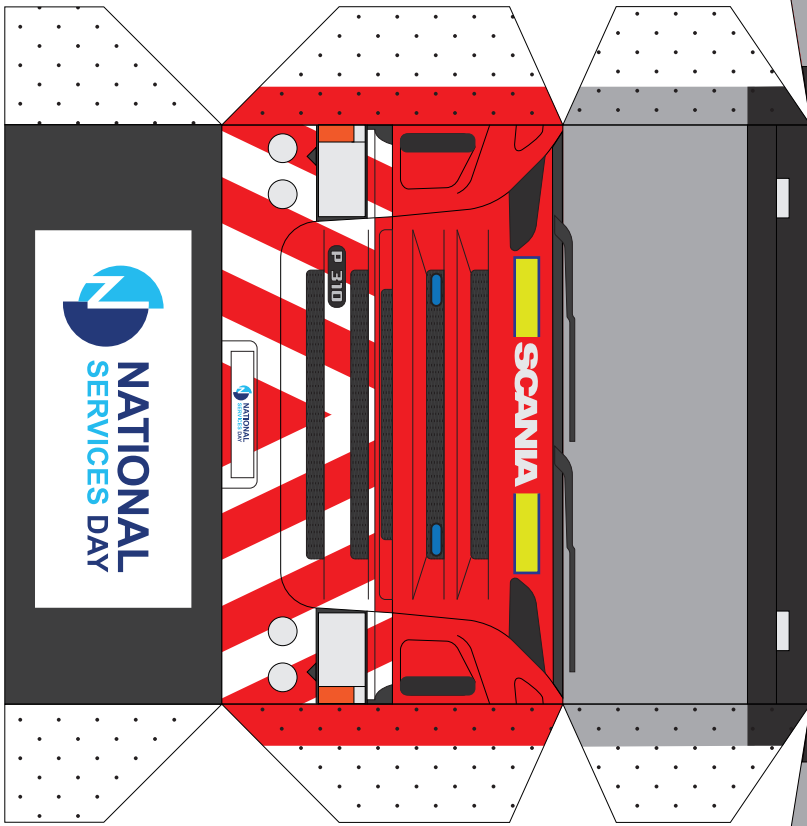

A





© Copyright robbloughlin.ie 2024. Not to be reproduced without permission.

B

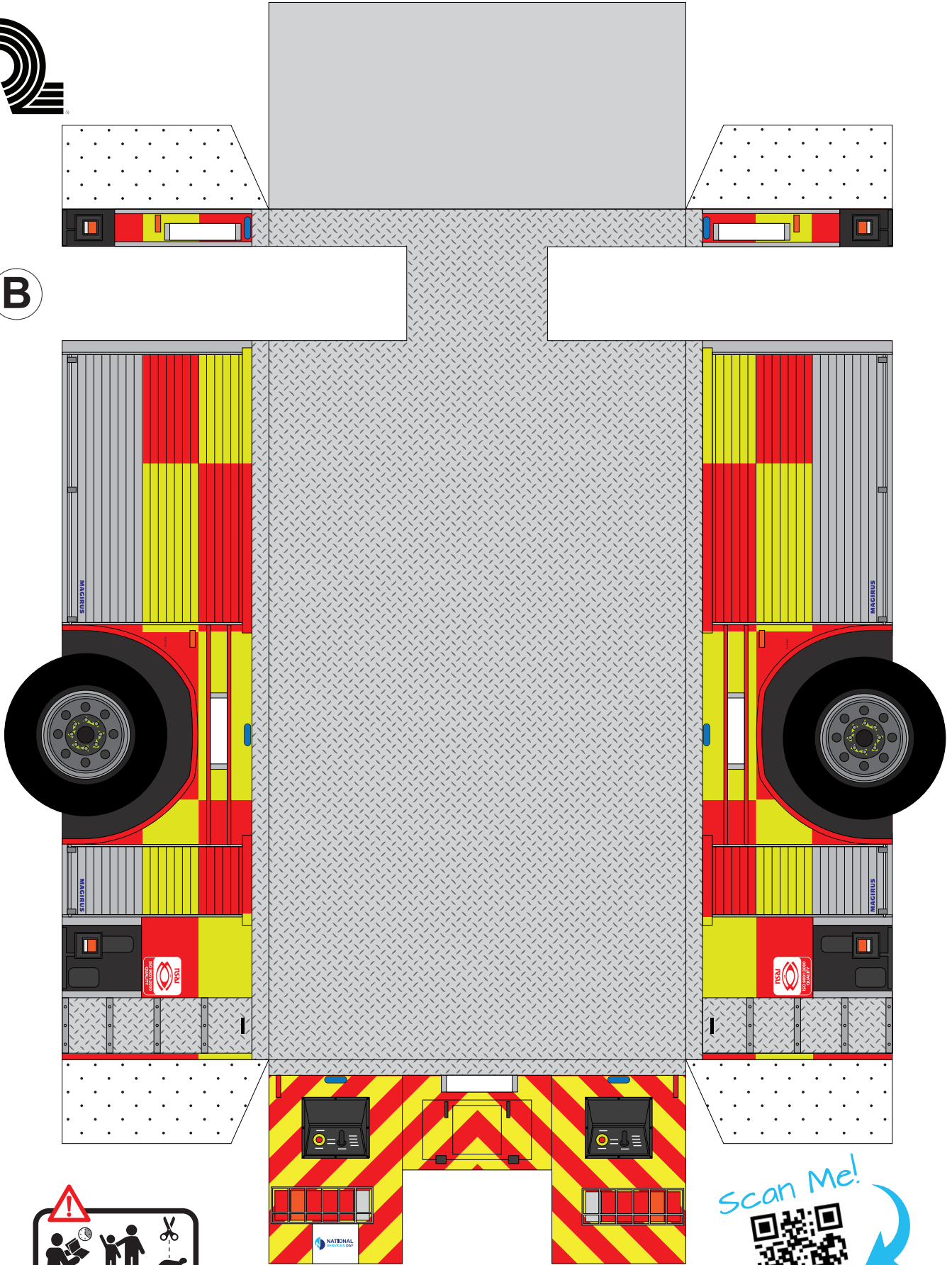



© Copyright roboughlin.ie 2024. Not to be reproduced without permission.

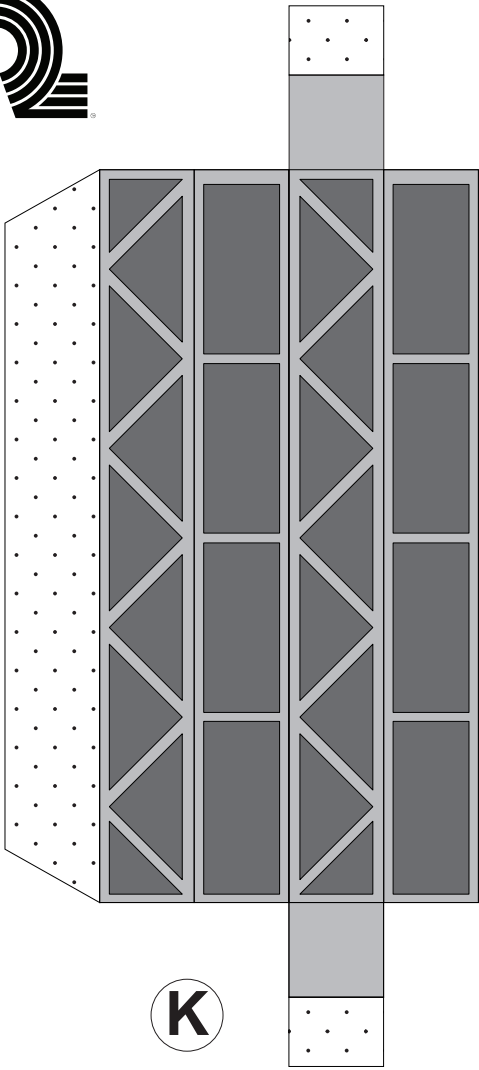

K



Scan Me!



H

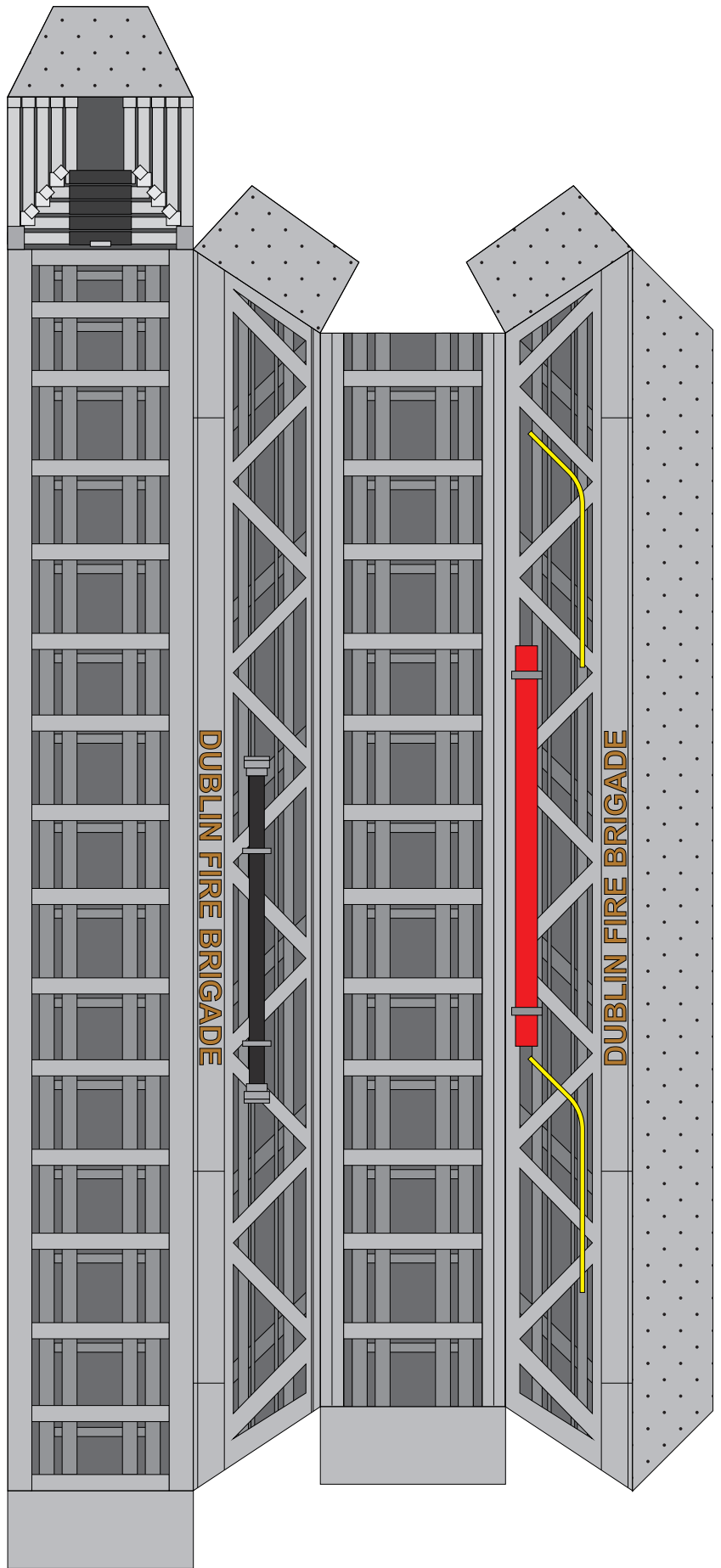



© Copyright robbloughlin.ie 2024. Not to be reproduced without permission.

Scan Me!



REMOVE THIS AREA

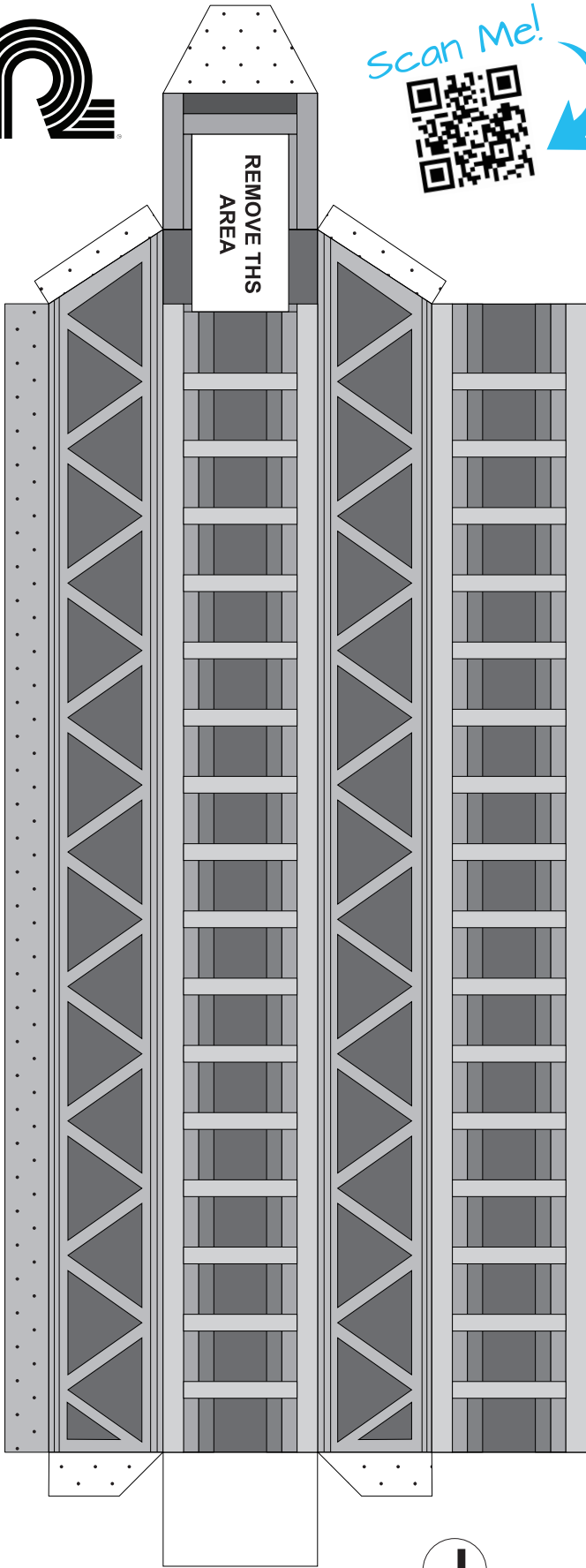

J

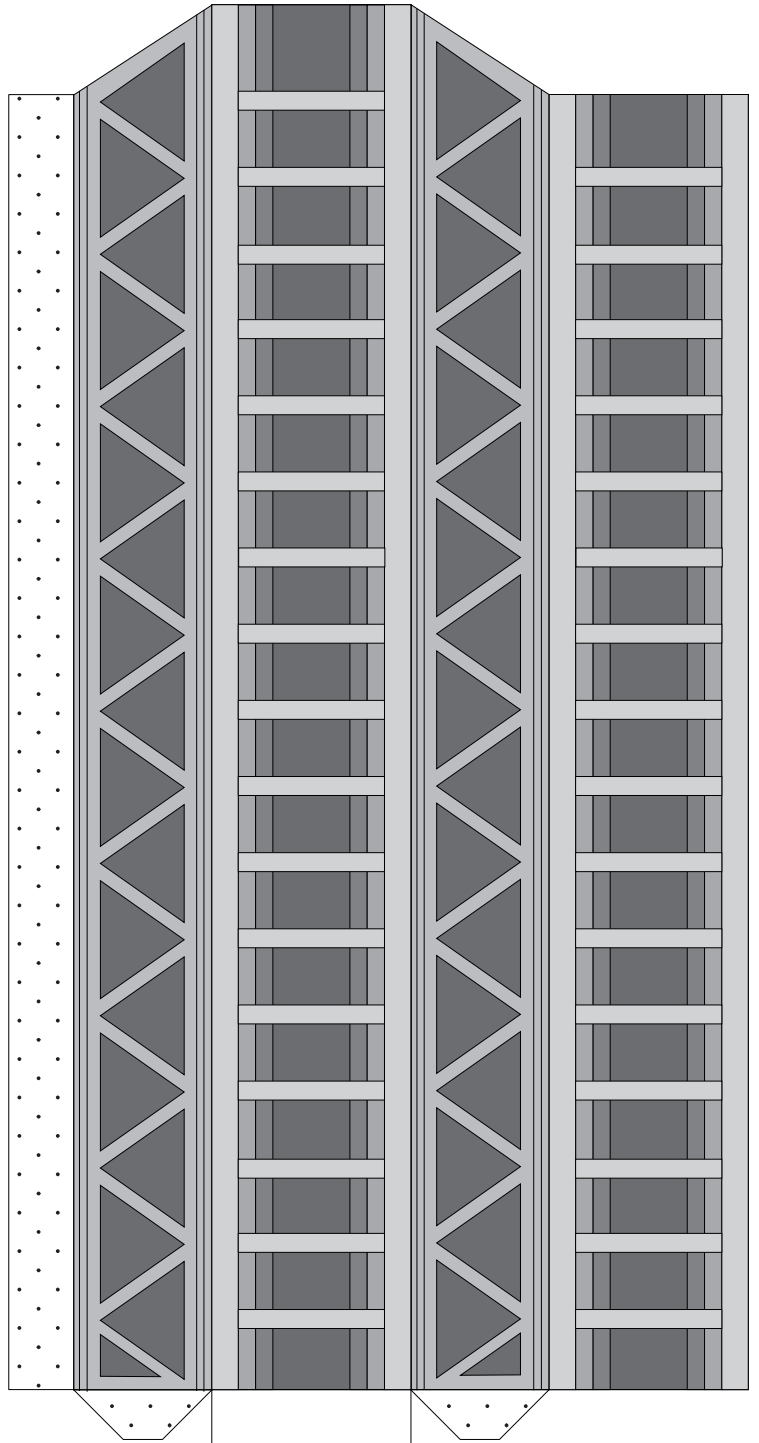

I





© Copyright robroughlin.ie 2024. Not to be reproduced without permission.

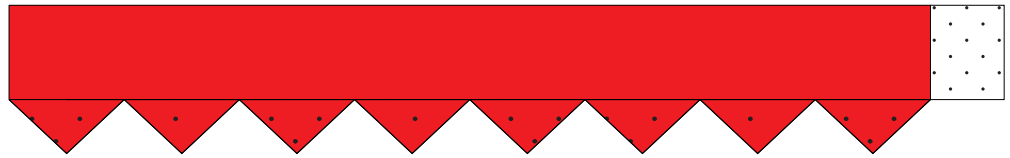

W

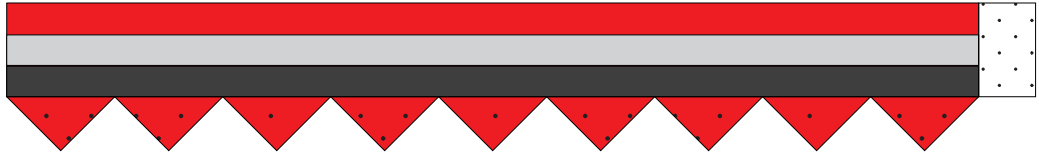

X

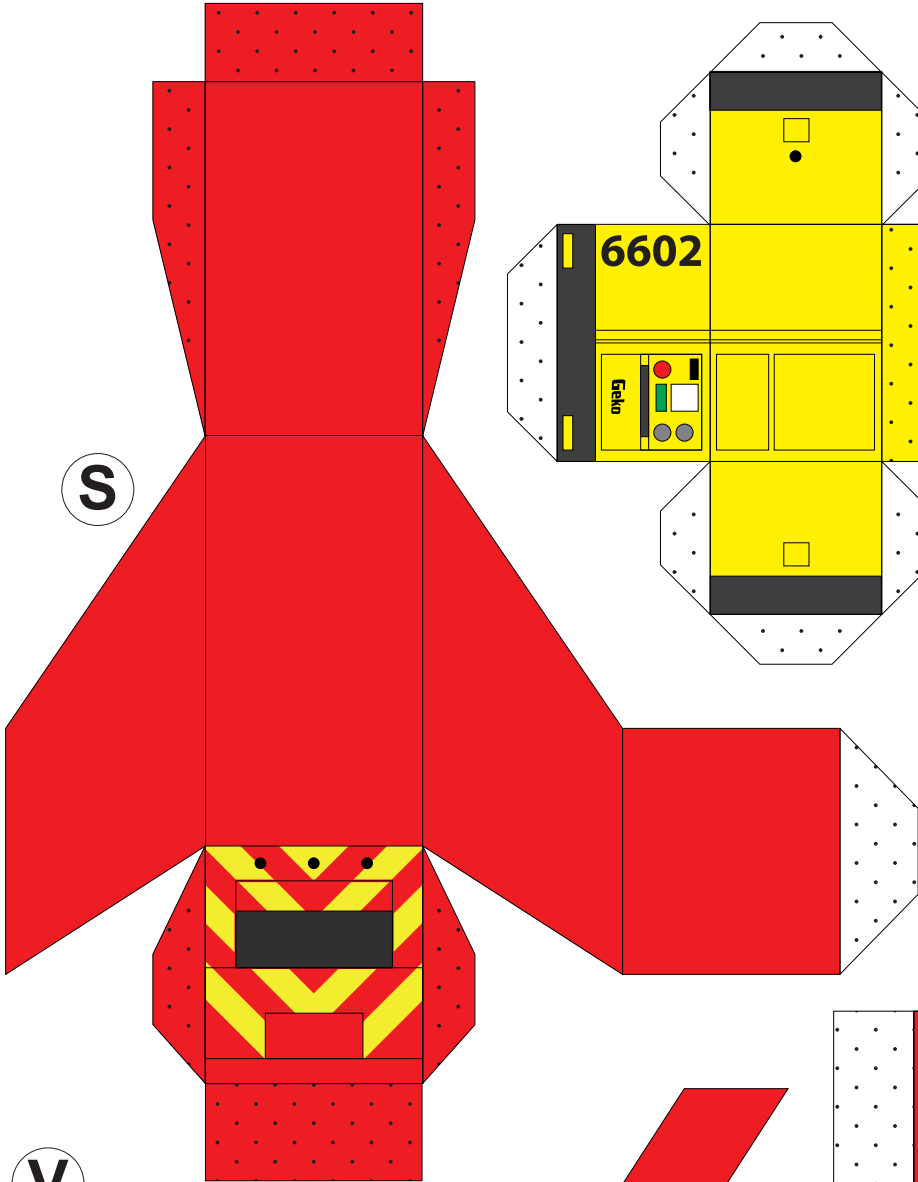

S

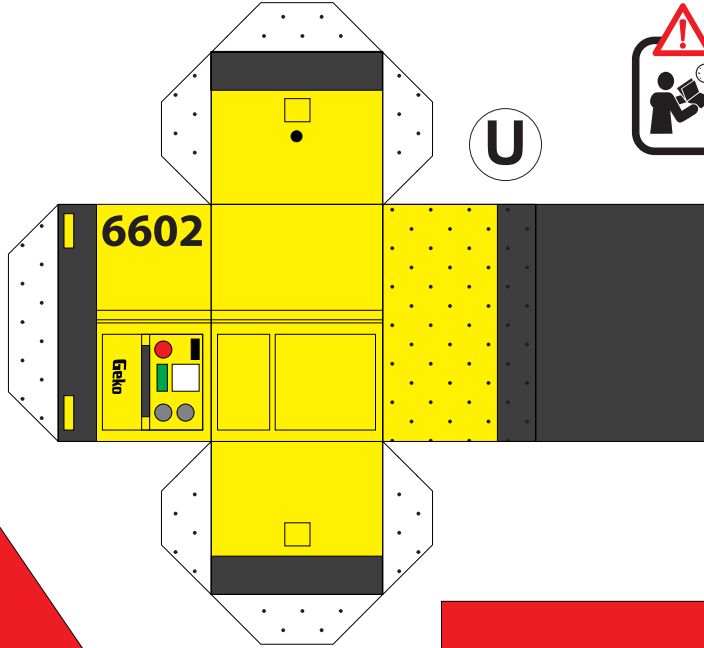

U



V

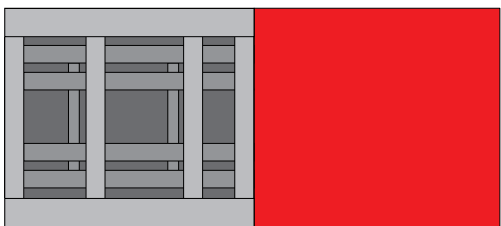

Y

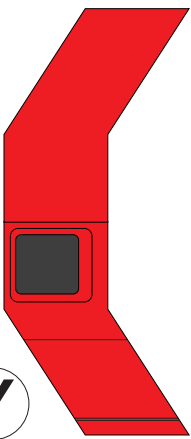

T

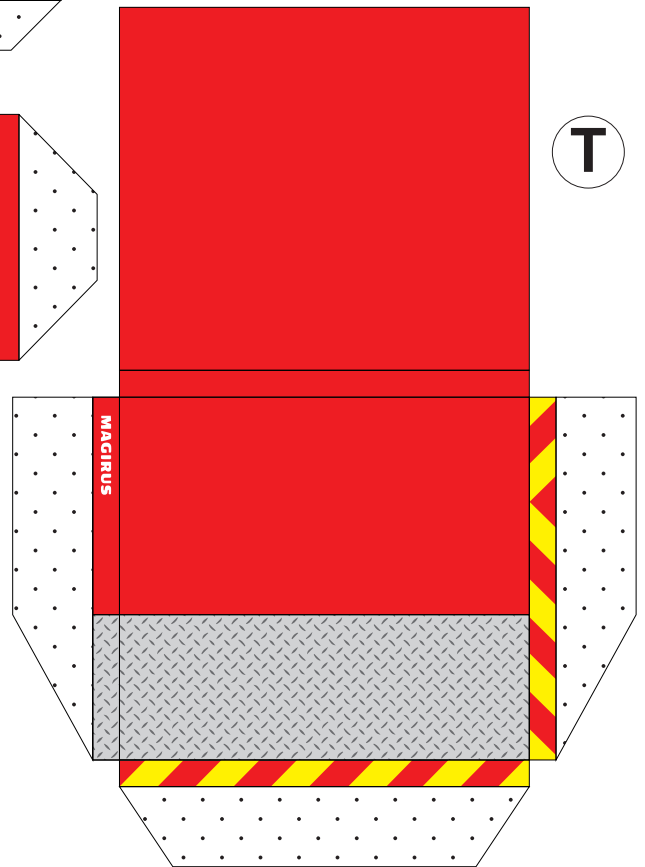



Q

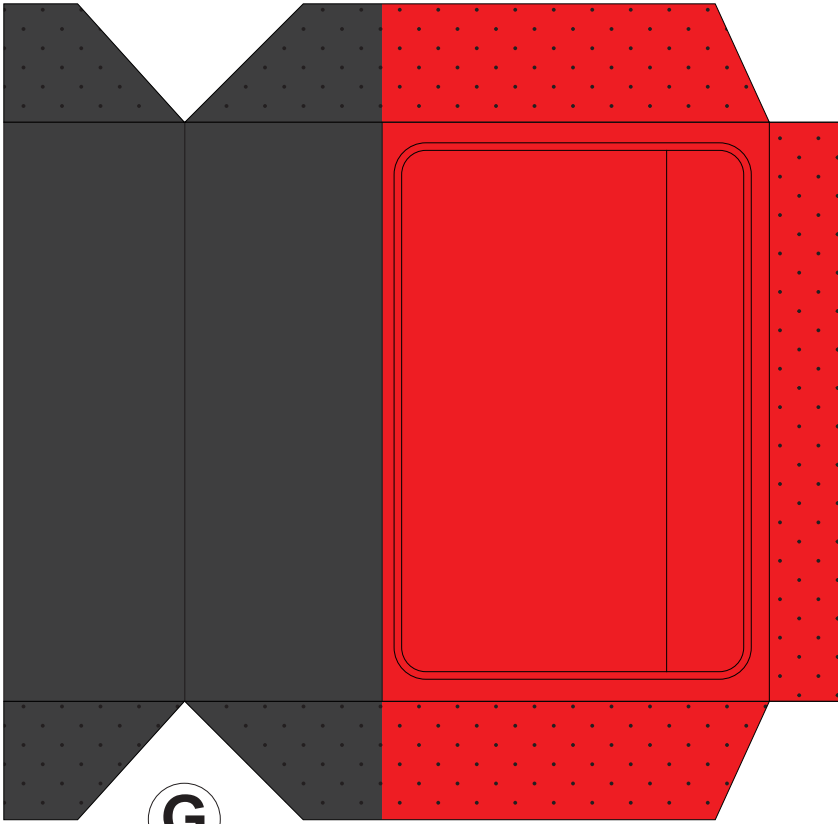
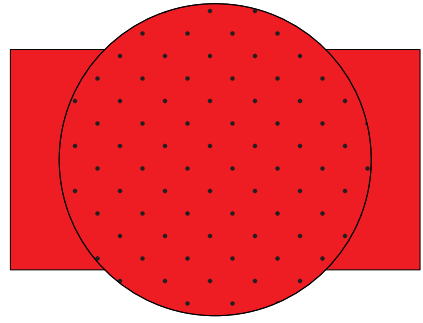

R

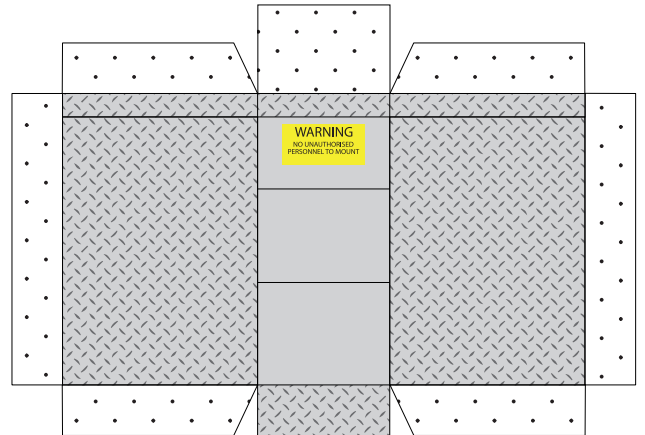
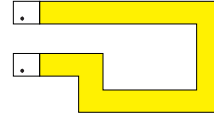

E

G



E

© Copyright roblooughlin.ie 2024. Not to be reproduced without permission.

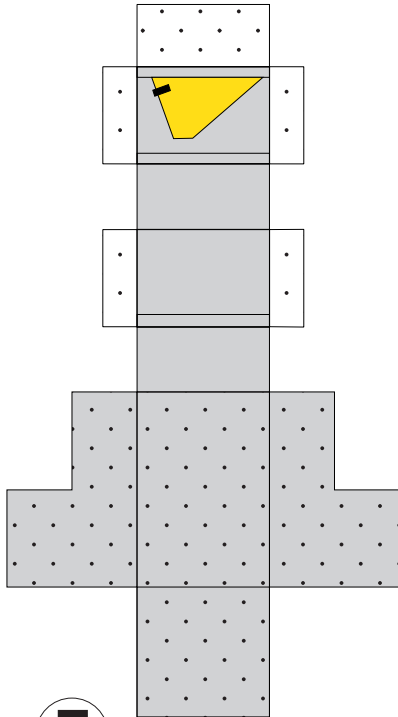

F

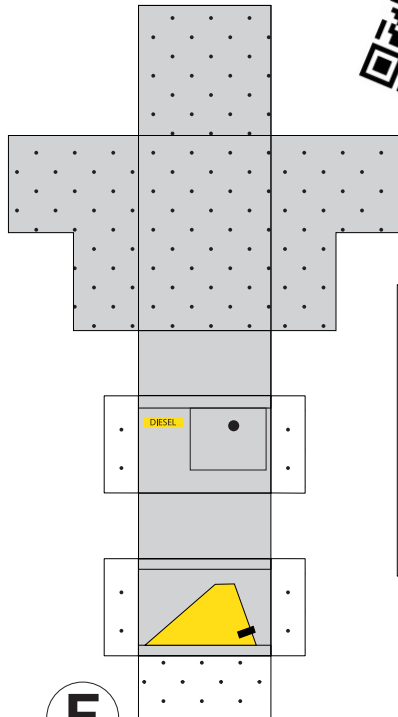

F

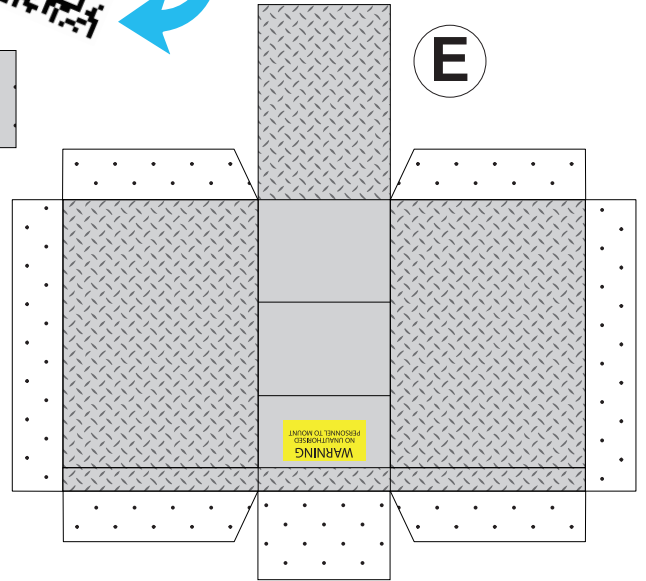



© Copyright roboughlin.ie 2024. Not to be reproduced without permission.

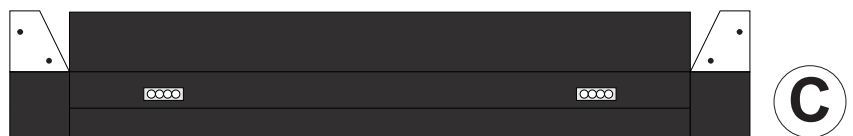
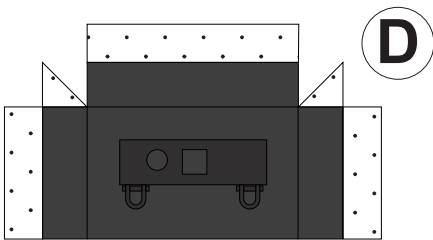
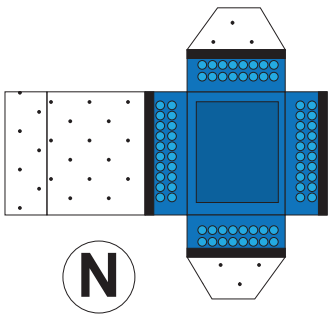
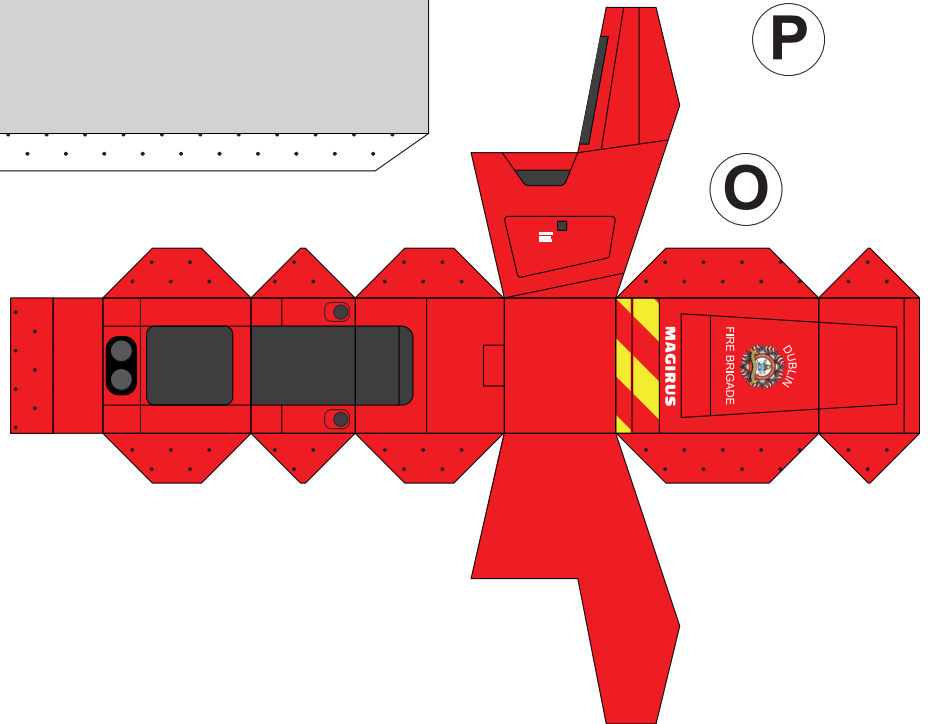
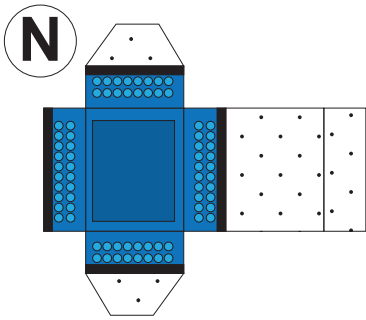
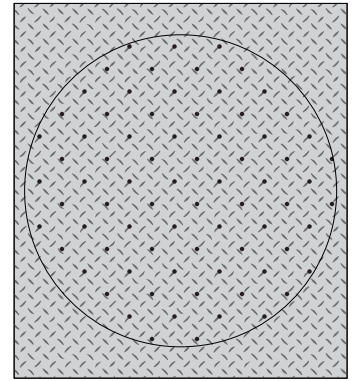
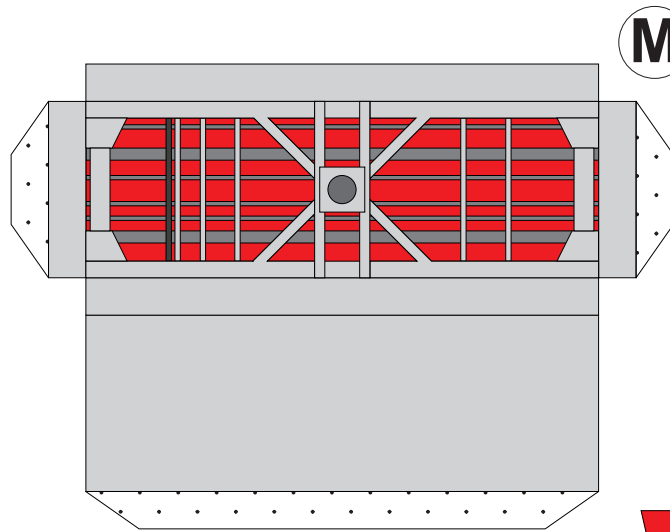
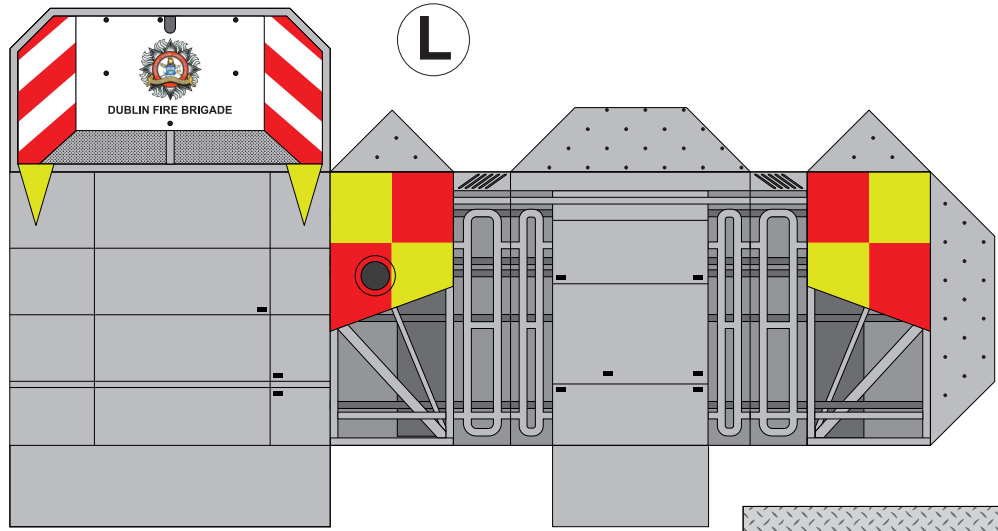

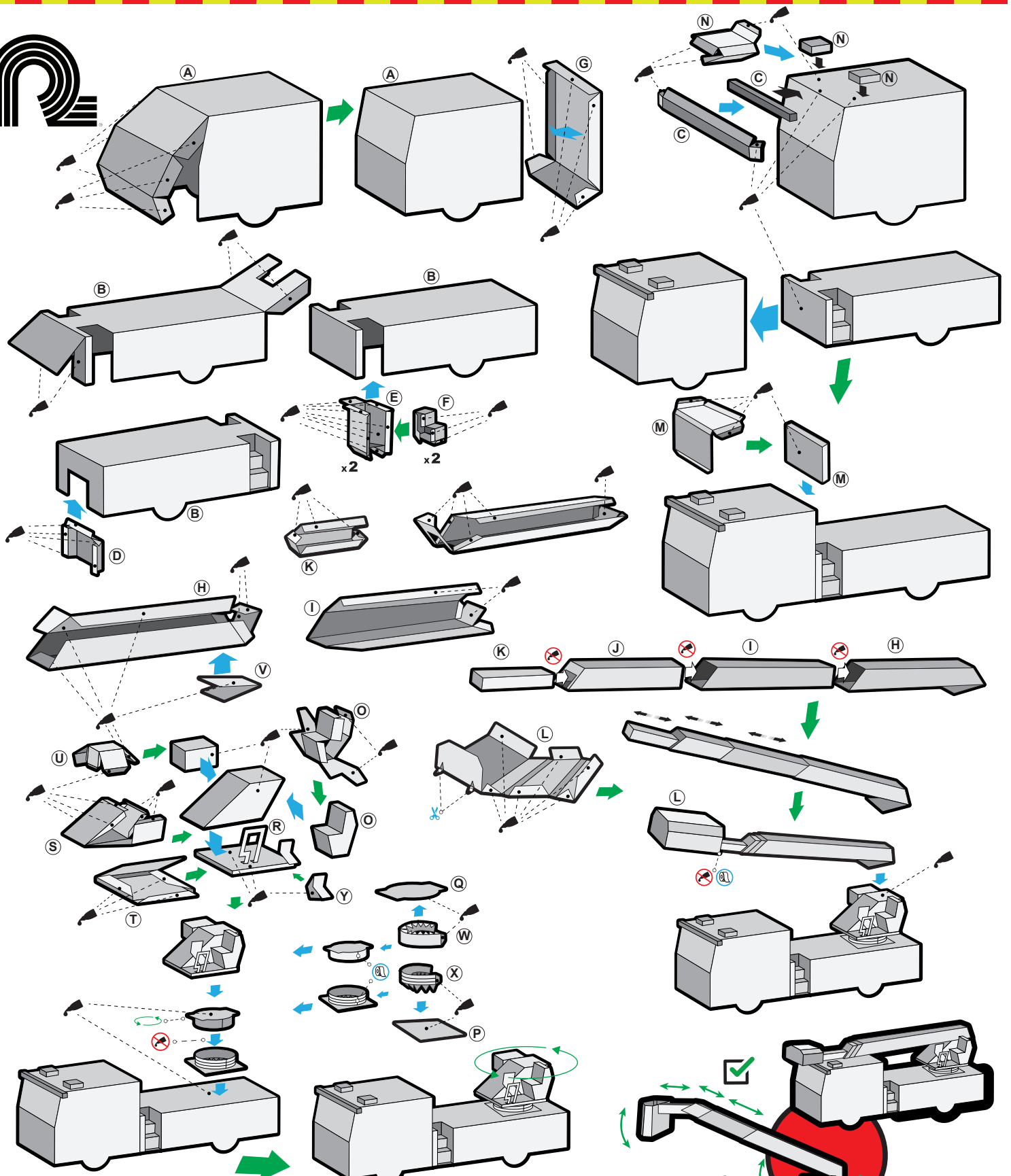

ASSEMBLY SHEET:
 Instructions: Look through all the pages first. See what lines have to be cut and which ones have to be scored and folded. Cut out the pieces carefully, then score and fold along the lines. Score the lines before folding. When applying glue, make sure to only place glue on the folded tabs. **For younger crafters, you might want to practice with paper before you make it out of card, or ask an adult to help with some of the cutting and folding.**

